

Ø 458

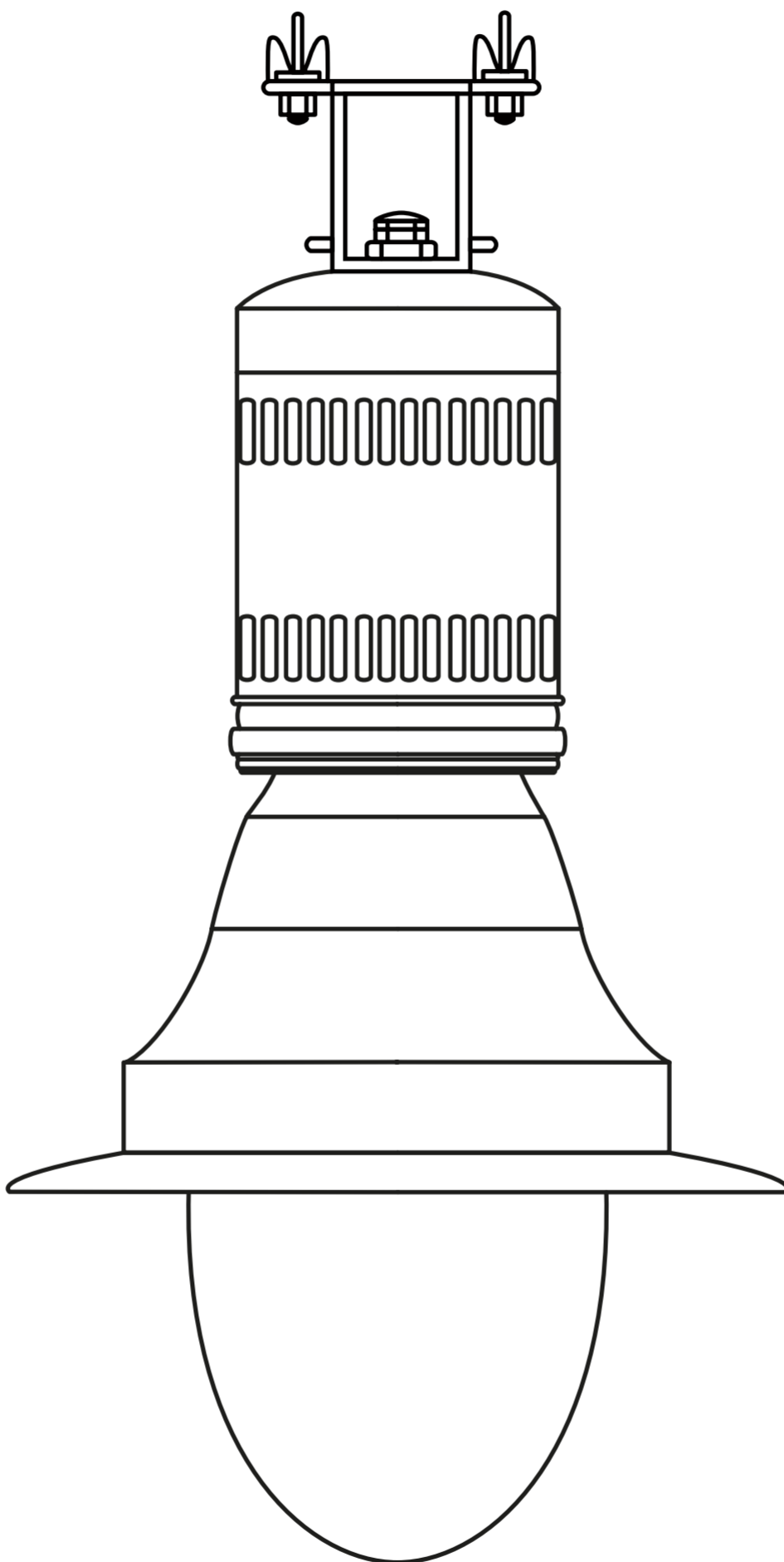

910