

Ø 480

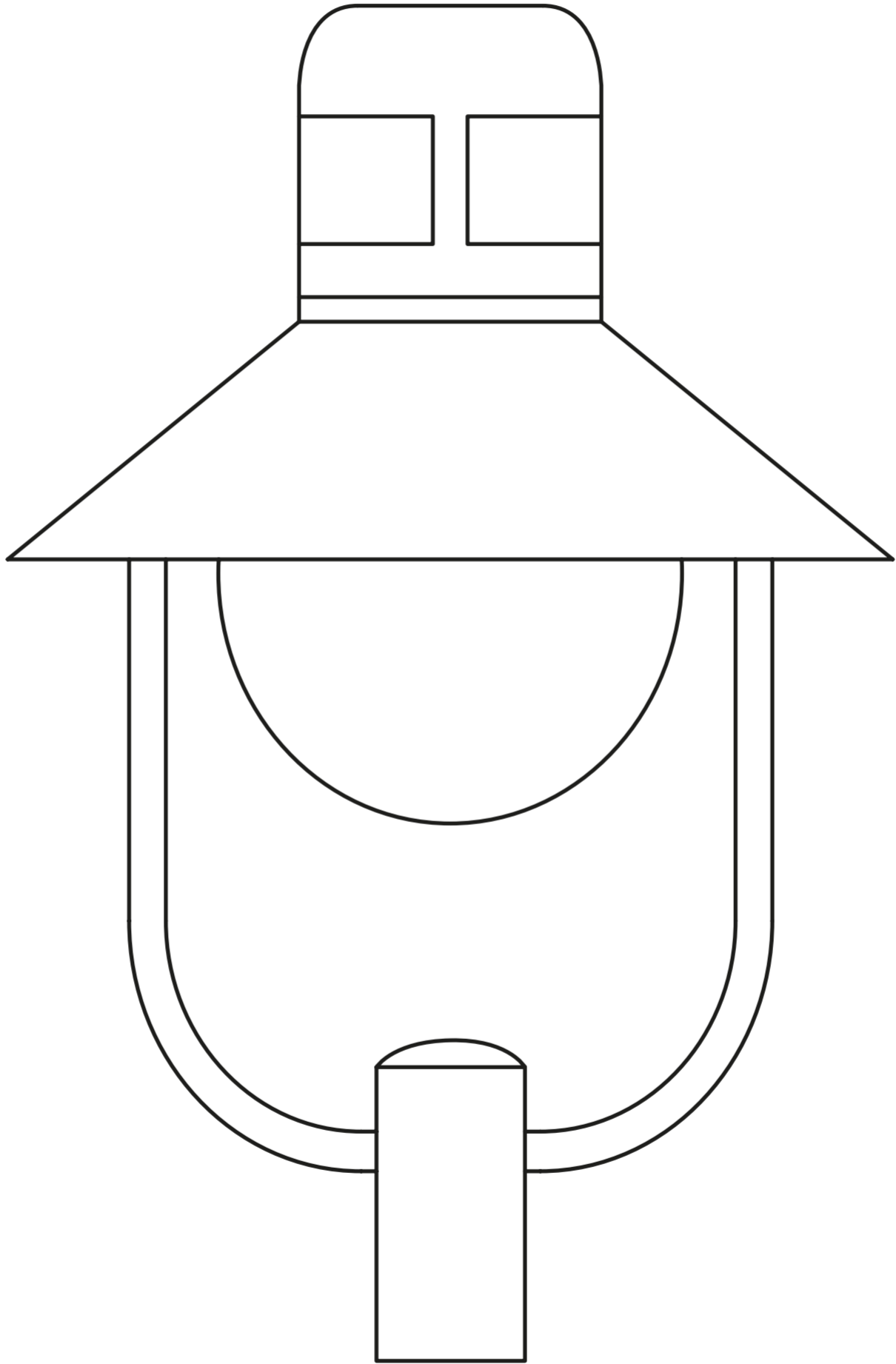

735